



■ Features

- DPDT configuration
- High sensitivity
- DIP standard terminals
- Sealed version
- Surge strength 1500V FCC68
- Clearance more than 1.2 mm between coil and contacts
- Creepage more than 1.9 mm between coil and contacts
- Conform to RoHS,ELV directive

■ Ordering Code

HJR1-2C D — 12VDC		
1	2	3
1. Relay Model	2. Coil Power: N=0.45W, D=0.36W, L=0.2W, M=0.15W	
3. Coil Nominal Voltage: 3, 5, 6, 9, 12, 24, 48VDC		

■ Coil Data (at 20°C)

Nominal Voltage(VDC)	3	5	6	9	12	24	48	
Coil Resistance(Ω)	60	167	240	540	960	/	/	0.15W
Rated Current(mA)	50	29.9	25	16.7	12.5	/	/	
Max Operate Voltage(VDC)	2.4	4	4.8	7.2	9.6	/	/	
Min Release Voltage(VDC)	0.15	0.25	0.3	0.45	0.6	/	/	
Coil Resistance(Ω)	45	125	180	405	720	2880	/	
Rated Current(mA)	66.7	40	33.3	22.2	16.7	8.3	/	0.2W
Max Operate Voltage(VDC)	2.25	3.75	4.5	6.75	9	18	/	
Min Release Voltage(VDC)	0.3	0.5	0.6	0.9	1.2	2.4	/	
Coil Resistance(Ω)	25	70	100	220	400	1600	6400	0.36W
Rated Current(mA)	120	72	60	40	30	15	85	
Max Operate Voltage(VDC)	2.25	3.75	4.5	6.75	9	18	36	
Min Release Voltage(VDC)	0.3	0.5	0.6	0.9	1.2	2.4	4.8	
Coil Resistance(Ω)	20	56	80	180	320	1280	5100	0.45W
Rated Current(mA)	150	89.2	75	50	37.5	18.7	10.6	
Max Operate Voltage(VDC)	2.25	3.75	4.5	6.75	9	18	36	
Min Release Voltage(VDC)	0.3	0.5	0.6	0.9	1.2	2.4	4.8	
Max Applicable Voltage	130% of nominal voltage at 70°C, 170% of nominal voltage at 23°C							

Note: Coil Resistance Tolerance of ±10% for 3-24VDC, Coil Resistance Tolerance of ±15% for 48VDC.

■ Contact Data

Contact Form	2Z
Contact Material	Silver Alloy
Load	Resistive Load(COSΦ=1)
Contact Ratings	1A 120VAC 2A 24VDC
Minimum Load	1mA 5VDC

Max Switching Voltage	240VAC/60VDC
Max Switching Current	2A
Max Switching Power	120VA/60W
Contact Resistance	100mΩMax at 6VDC 1A
Life Expectancy	Electrical: 100,000 Operations (at 30 Operations/minute)
	Mechanical: 10,000,000 Operations (at 300 Operations/minute)

■ Characteristics Data

Insulation Resistance	100MΩMin at 500VDC
Dielectric Strength Between Open Contacts	500VAC (for one minute)
Between Contacts and Coil	1000VAC (for one minute)
Operate Time	8ms
Release Time	4ms
Temperature Range	-30°C to +85°C
Shock Resistance	Operating Extremes: 10G Damage Limits: 50G
Vibration Resistance	10-55Hz, 1.5mm
Max. Switching Frequency	Mechanical: 18,000 operations/hr Electrical: 1,800 operations/hr
Humidity	40-85%
Weight	Approx: 5g
Safety Standard	UL cUL TÜV

■ Approved Standards

Model	Coil Rating	Safety Standard	Contact Rating
HJR1-2C	3 to 48VDC	TÜV	0.5A 120VAC 1A 24VDC
		UL/cUL	1A 120VAC 2A 24VDC

■ Engineering Data

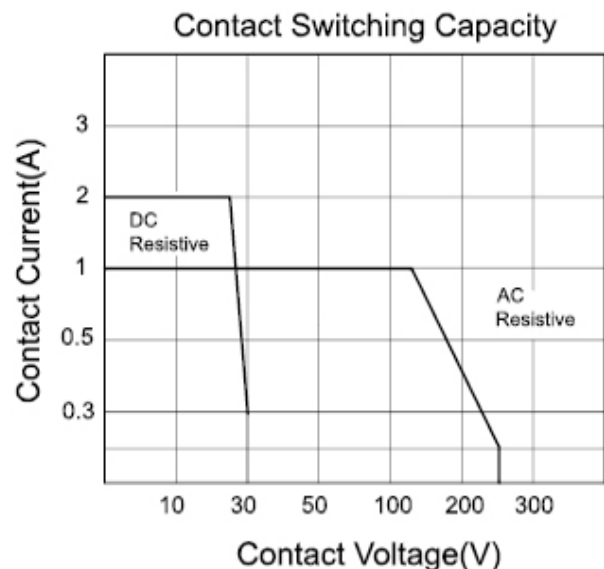
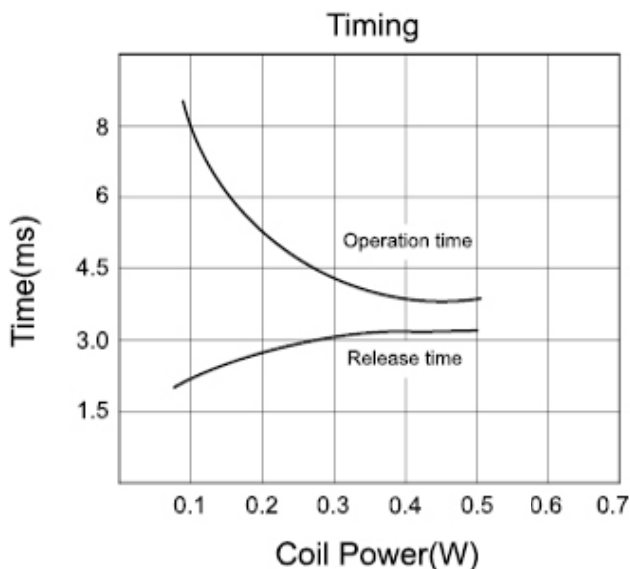

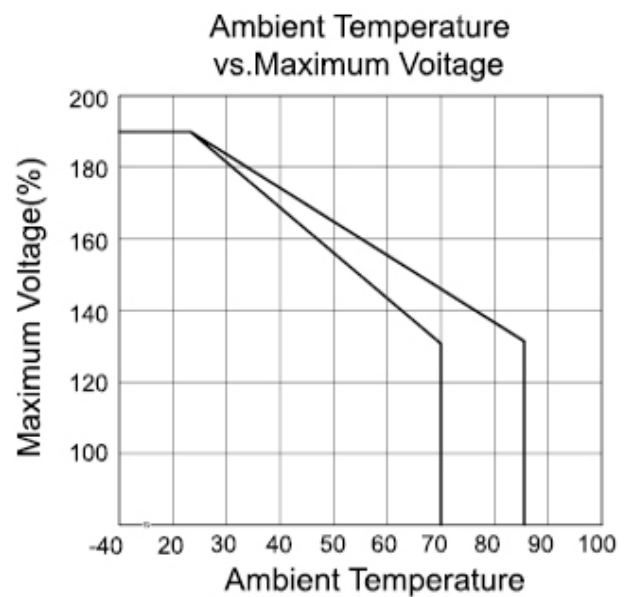
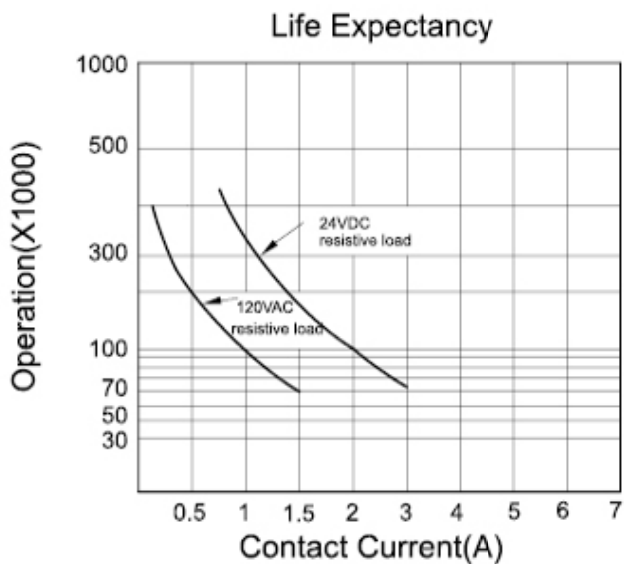

■ Overall and Mounting Dimensions

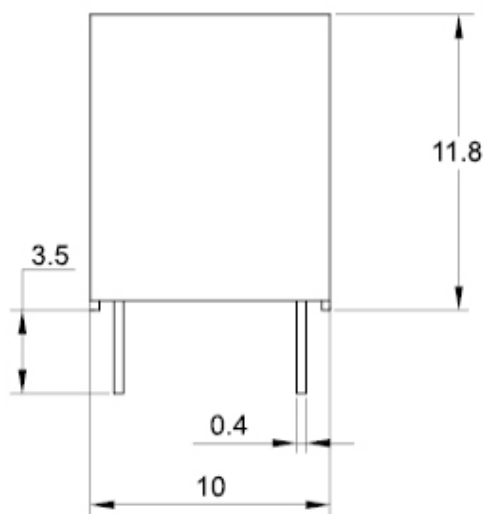

PCB Layout

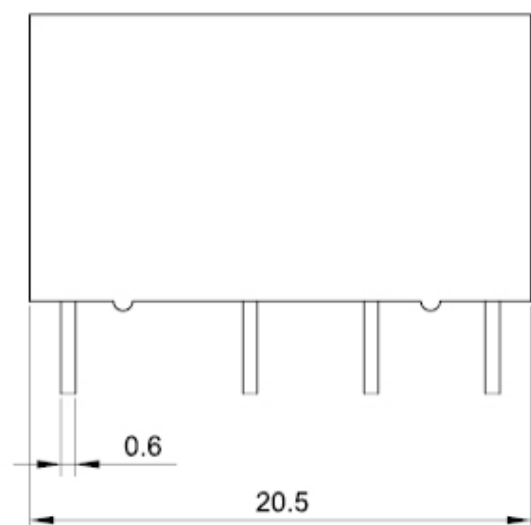

Wiring Diagram

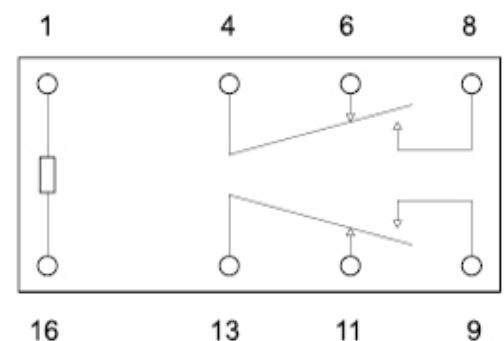
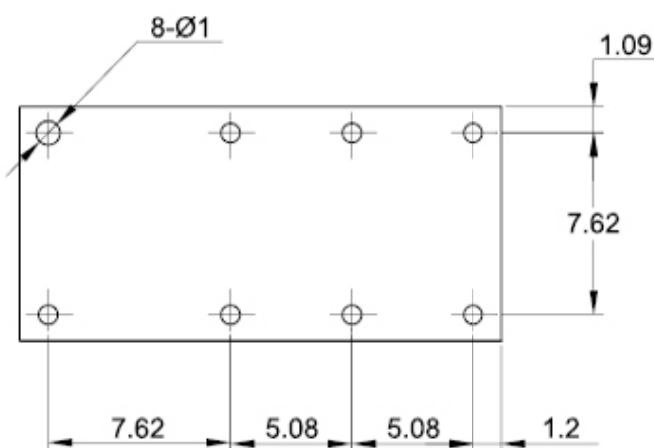

Remark:

- 1). In case the tolerance is not shown in outline dimension, the tolerance should be $\pm 0.2\text{mm}$ for outline dimension $\leq 1\text{mm}$; $\pm 0.3\text{mm}$ for outline dimension: 1~5mm and $\pm 0.4\text{mm}$ for outline dimension $> 5\text{mm}$.
- 2). The tolerance without indication is always $\pm 0.1\text{mm}$ for the dimension of PCB layout.

Disclaimer:

These specifications are just for customers' reference and subject to change without notice.